



T310

Current Vector Inverter



T310

The launch of T310 series Inverter is the strong debut of Taian Technology, which meets customers requirements and shows our strong R&D capabilities.



T310

Three motor control modes

Diversified control modes for various industries and machine applications.

Environmental adaptation

The whole series is designed with a ventilation function to diminish the accumulation of cotton wool and dust.
1-75HP, for the electronic parts, Coating Circuit boards, the enclosure does not have heat dissipation holes, contributing to improving the environmental resistance.

Up-to-date Auto-tuning technology

Advanced Auto-tuning function of rotary, static and linear resistance measuring motors.

High-order current vector technology

Support high performance current vector control for Asynchronous and synchronous motors.
Activate motor performance to optimum condition

Dramatic improvement in core computation performance

Dual-core computation
MCU clock is increased by nearly five times to provide high speed processing.



The current vector T310 features intelligent over-voltage suppression in addition to auto-tuning technology, for high regenerative energy situations, which can save the cost of brake device.

T310 series is specially designed for the environment resistant : 1-75HP, for the electronic parts, Coating Circuit boards, the Enclosure does not have heat dissipation holes; A full range of cooling fan is designed for ventilation and has quick-replacement function.

Advanced motor Auto tuning function

Three motor Auto tuning modes	
Rotary type	Suitable for the requirements of high starting torque, high speed and high precision.
Static type	Used when the motor is connected to a mechanical load shaft, and the motor shaft is static during tuning.
Cable resistance measuring type	When the inverter is connected to a long motor cable, the motor cable resistance can be measured and automatically compensated to improve control accuracy.

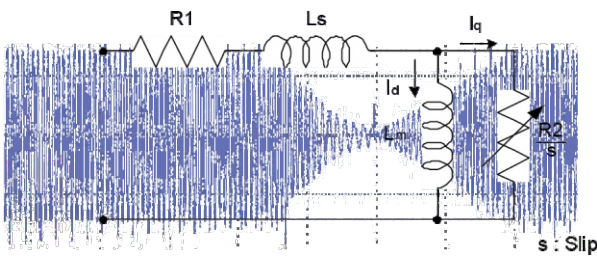

Whether the motor tuning technology is superior or inferior plays a pivotal role in the control performance!

Core computation enhancement

- Core chips and hardware are updated and evolved to enable faster responses.

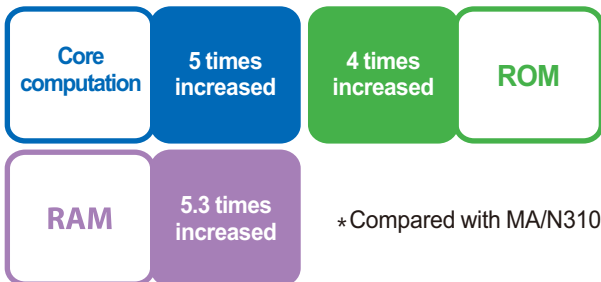

Comply with international standards

- The whole series is in line with European RoHS directive, and the standard products shall not contain six hazardous substances such as Pb/Hg/Cd/Cr+6/PBB/PBDE.

RoHS

- Comply with international CE.



180%

0.6Hz Sensorless current vector technology

Sensorless current vector control mode, with a maximum torque of 180% at 0.6Hz, which corresponds to various variable loads and provides a stable and reliable control performance.

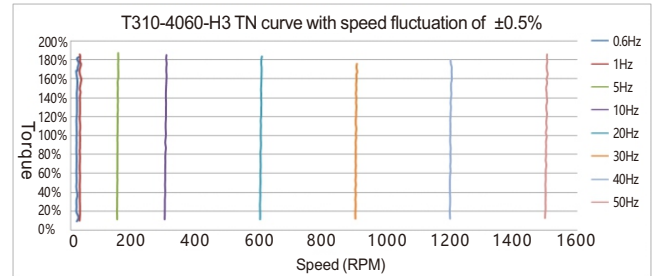

Measured data (torque sensor model JN338-500)

Notes for test conditions: The above data are actually measured in the laboratory, and the maximum torque data varies slightly with the different design parameters of the motor from the customer. The performance is used only for customer reference.

DriveLink

- User-friendly DriveLink computer operation interface
Users can use Pes.pc software to read, edit, store and compare the parameters of T310 inverter conveniently and efficiently.

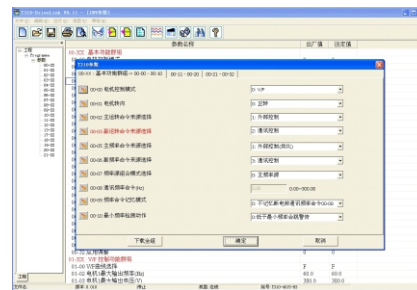

- DriveLink real-time running curve and data

Users can collect the running data of T310 inverter fast in real-time manner and observe the dynamic curve in real time.

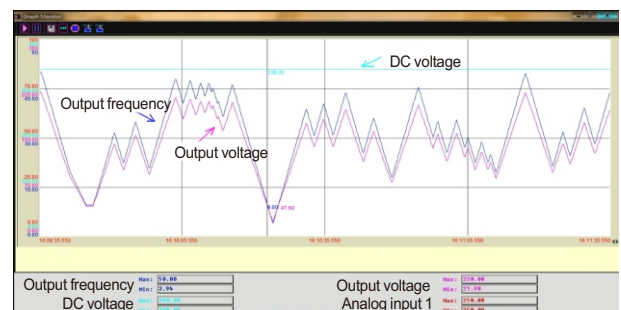

Fan quick disassembly and speed control

- Flexibly adjust the operation of the fan according to the environment and load, so as to effectively reduce the noise and prolong the service life of the fan.
- User-friendly design, convenient and quick replacement of fan without complicated disassembly and assembly procedures.

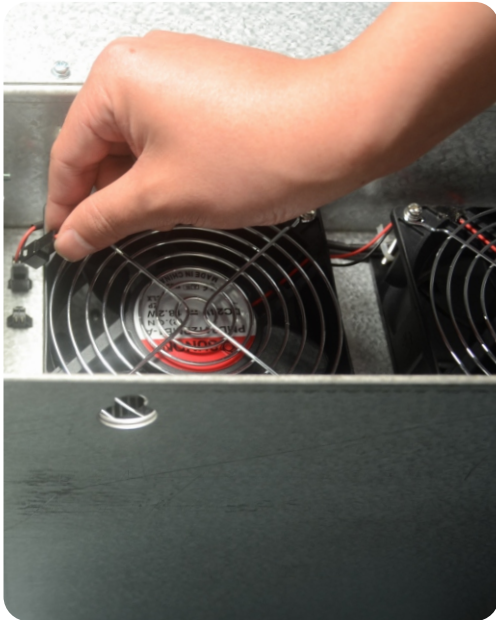

Enclosure sealing design

- For 1-30HP, the Enclosure is designed with no heat dissipation holes to effectively isolate dust.
- For 40-75HP, Enclosure is designed without heat dissipation holes, except for DC reactor with heat dissipation holes.



- Only the terminal block is exposed after the upper cover is removed to effectively protect PCB.



Intelligent over-voltage suppression function

- It is specially designed for regenerative energy loads such as punching machines and screw processing machines to avoid over-voltage tripping of the inverter. The intelligent over-voltage suppression function can guide regenerative energy to recharge the load in real time, effectively protecting the inverter. This mechanism also reduces the energy consumption of the machine and saves the cost of brake resistors and other devices for the mechanical operators.

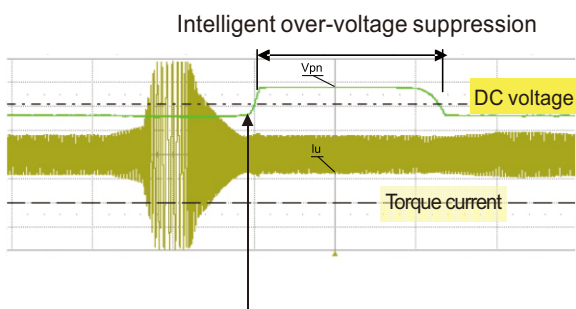

Instantaneous energy recharges, and DC voltage rises

System wiring diagram

The following is the standard wiring diagram of T310 inverter (⊕ indicates high-voltage power circuit terminal and ○ indicates control circuit terminal). For T310 series, the position and symbol of wiring terminal block may be slightly different depending on the model.

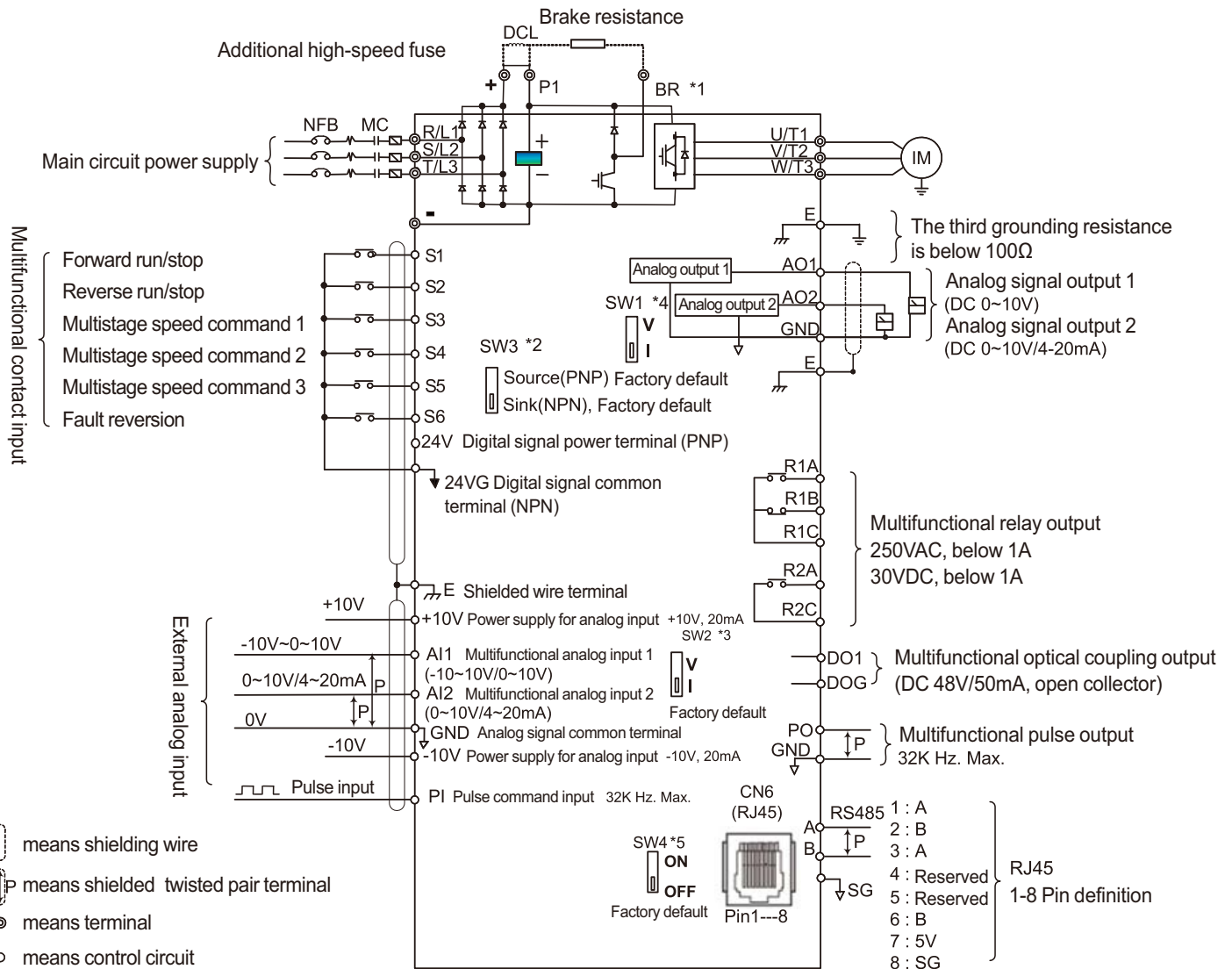

Descriptions:

- *1: 380V 15-30HP: built-in brake crystal, which can directly connect the brake resistor between P1 and BR; External DCL (between ⊕-P1) is reserved; 380V 40~215HP: built-in DCL, with no built-in brake crystal, and the external brake unit can be connected between ⊕- ⊙.
- *2: Multifunctional digital input contacts S1-S6 can be set to source (PNP, with +24V common) or sink (NPN, with 24VG common) by switch SW3.
- *3: Multifunctional analog input AI2 can be set to voltage command input (0-10V) or current command input (4-20mA) by switch Sw2.
- *4: Multifunctional analog output AO2 can be set to voltage command output (0-10V) or current command output (4-20mA) by switches SW1 (1-75HP) or SW6 (100-535HP).
- *5: RS485 terminal resistance switch. When multiple inverters are used in parallel, the last inverter should be turned on. The ground signal of RS485 is SG, which is isolated from GND of analog signal. A is equal to S+, B is equal to S-.

Model description

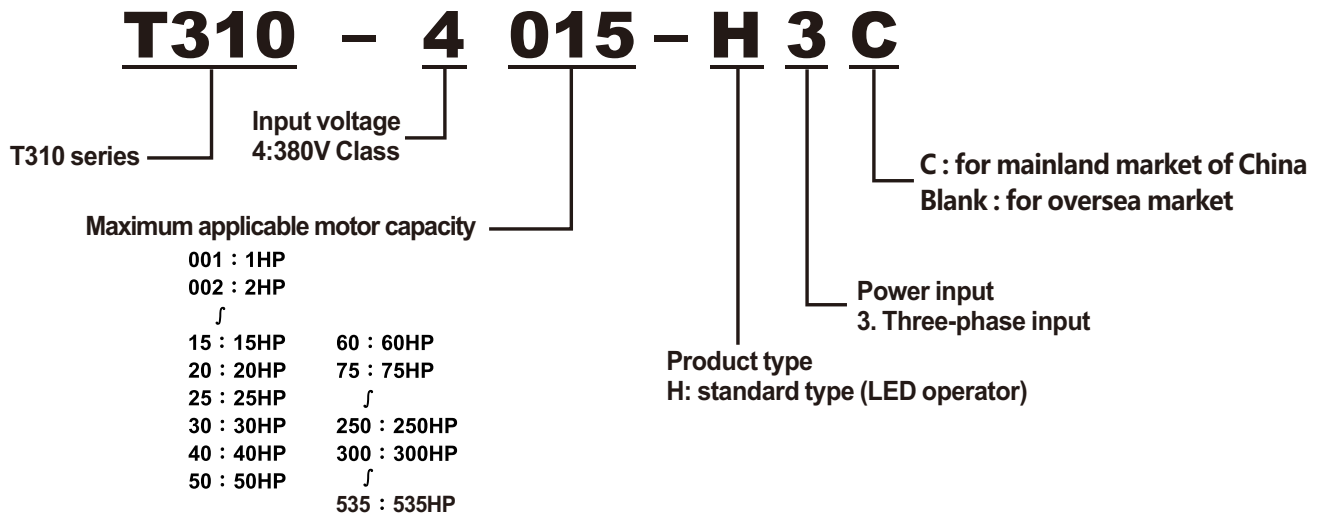

Basic specification

Inverter capacity (HP)		1	2	3	5	8	10	15	20	25	30	40	50	60	75	
Output rating	Heavy duty type H.D.(150%/min)	Rated output capacity (kVA)	2.6	3.2	4.2	7	11.3	13.7	18.3	23.6	29.7	34.3	45.7	57.2	69.3	89.9
		Rated output current (A)	2.3	4.2	5.5	9.2	13	18	24	31	39	45	60	75	91	118
		Maximum applicable horsepower *1 HP(kW)	1 (0.75)	2 (1.5)	3 (2.2)	5 (3.7)	7.5 (5.5)	10 (7.5)	15 (11)	20 (15)	25 (18.5)	30 (22)	40 (30)	50 (37)	60 (45)	75 (55)
	Normative duty type N.D.(120%/min)	Rated output capacity (kVA)				8.5	13.3	17.5	23.6	29.0	33.5	44.2	54.9	67.1	78.5	111
		Rated output current (A)				13	18	23	31	39	45	60	75	91	118	145
		Maximum applicable horsepower *1 HP(kW)				7.5 (5.5)	10 (7.5)	15 (11)	20 (15)	25 (18.5)	30 (22)	40 (30)	50 (37)	60 (45)	75 (55)	100 (75)
Maximum output voltage (V)		Three-phase 380V~440V														
Maximum output frequency (Hz)		Set by parameters, 0.1~599 Hz														
Power supply	Rated voltage, frequency		Three-phase 380V~440V, 50/60Hz													
	Allowable voltage variation		-15%~+10%													
	Allowable frequency variation		±5%													

Inverter capacity (HP)		100	125	150	175	215	250	270	300	335	375	425	475	535		
Output rating	Heavy duty type H.D.(150%/min)	Rated output capacity (kVA)	114	137	165	198	232	282	290	343	343	398	446	495	552	
		Rated output current (A)	150	180	216	260	304	370	380	450	480	523	585	650	725	
		Maximum applicable horsepower *1 HP(kW)	100 (75)	125 (90)	150 (110)	175 (132)	215 (160)	250 (185)	270 (200)	300 (220)	335 (250)	375 (280)	425 (315)	475 (355)	535 (400)	
	Normative duty type N.D.(120%/min)	Rated output capacity (kVA)	137	159	198	232	250	332	332	366	366	446	488	552	625	
		Rated output current (A)	180	208	260	304	328	435	435	480	523	585	640	725	820	
		Maximum applicable horsepower *1 HP(kW)	125 (90)	150 (110)	175 (132)	215 (160)	250 (185)	300 (220)	300 (220)	335 (250)	375 (280)	425 (315)	475 (355)	535 (400)	600 (450)	
Maximum output voltage (V)		Three-phase 380V~440V														
Maximum output frequency (Hz)		Set by parameters, 0.1~599 Hz														
Power supply	Rated voltage, frequency		Three-phase 380V~440V, 50/60Hz													
	Allowable voltage variation		-15%~+10%													
	Allowable frequency variation		±5%													

Common specification

Control characteristic	Operation mode	Seven-stage display *5 + Key LED operator (with potentiometer knob setting)
	Control mode	V/F, SLV, SLV2 and PMSLV modes based on space vector PWM
	Frequency control range	0.1Hz~ 599.0Hz
	Output frequency accuracy (temperature variation)	Digital instruction: $\pm 0.01\%$ (-10 - +40°C), analog instruction: $\pm 0.1\%$ (25°C $\pm 10^\circ\text{C}$)
	Speed control accuracy	$\pm 0.5\%$ (sensorless vector control)
	Frequency setting resolution	Digital instruction: 0.01Hz, analog instruction: 0.03Hz/60Hz (when the maximum output frequency of the motor exceeds 300Hz, the frequency resolution is 0.1 Hz)
	Output frequency resolution	0.01 Hz (when the maximum output frequency of motor exceeds 300Hz, the frequency resolution is 0.1 Hz)
	Overload capacity	The rated output current is 150%/min (H.D. heavy duty type), 120%/min (N.D. normative duty type), and the factory default is 150%/min.
	Frequency setting signal	DC 0 ~ +10V/4 ~ 20mA or DC -10V ~ +10V and pulse frequency instruction
	Acceleration and deceleration time	0.1-6000.0 sec (acceleration and deceleration time can be set separately)
	Voltage, frequency characteristics	The V/f curve can be set by parameters arbitrarily
	Regenerative braking torque	About 20%
	Main control function	Auto-tuning, Soft-PWM, over-voltage protection, dynamic braking, speed searching, frequency wobbling, instantaneous power outage restart, PID control, automatic torque compensation, slip compensation, RS-485 communication standard, 2 sets of analog output contacts.
	Other functions	Cumulative record of power-on time and running time, four sets of fault history and status record of the latest fault, energy saving function setting, phase-loss protection, intelligent brake, DC brake, S-curve acceleration and deceleration, Up/Down operation, MODBUS communication format, pulse multiple output, and optional SINK/SOURCE input interface.
Protective function	Stall prevention	Adjustable action current (adjustable separately during acceleration and constant speed, and can set enable/disable during deceleration)
	Transient over-current protection (OC) Output short circuit protection (SC)	Stop over 200% of rated current of inverter
	Inverter overload protection (OL2)	The rated current of the inverter is 150%/min, and the factory default Carrier Frequency is 8~2kHz. The rated current of the inverter is 120%/ min (N.D. normative duty type), and the factory default Carrier Frequency is 4~2KHz.
	Motor overload protection (OL1)	Electronic overload curve protection
	Over-voltage protection (OV)	The DC voltage of the main circuit is above 820V (380V class), and the motor stops .
	Under-voltage protection (UV)	The DC voltage of the main circuit is above 380V (380V class), and the motor stops .
	Automatic restart after instantaneous power failure	In case of power failure for more than 15ms, the function of automatic restart after instantaneous power failure within 2 sec can be set
	Overheat protection (OH)	Protection with temperature detector
	Grounding protection (GF)	Protection with current detector
	Charging display	When the DC voltage of the main circuit is $\geq 50\text{V}$, the LED indicator lights up during charging.
	Output phase loss (OPL)	In case of Output phase loss, the motor stops running.
Operational environment	Place of use	Indoor (places without corrosive gas and dust)
	Ambient temperature	-10 ~ +40°C (IP20), -10 ~ +50°C (IP00), if derating, it can work at 60°C
	Storage temperature	-20 - +70°C
	Humidity	Below 95% RH (no condensation)
	Altitude, vibration	Below 1000m above sea level; 1.0G, comply with ICE 60068-2-6
Communication function	RS-485 standard built-in (MODBUS)	
Noise interference prevention (EMI)	Additional noise filters comply with EN61800-3	
Noise interference tolerance (EMS)	Comply with EN61800-3	

Product dimension

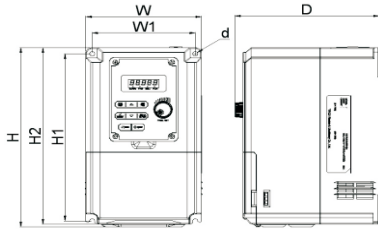

(Figure A) 380V: 1~8HP (IP20)

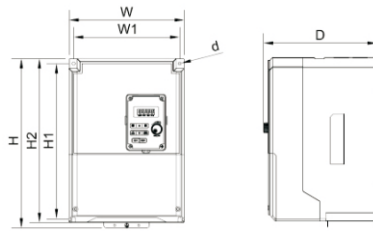

(Figure B) 380V: 10~20HP (IP20)

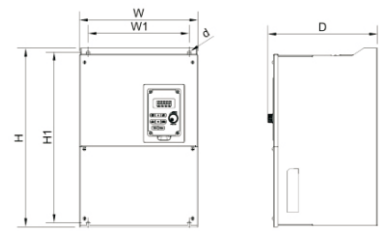

(Figure C) 380V: 25~30HP (IP20)

Figure	Inverter model	Overall dimension (mm)								Net weight (kg)	Remarks
		W	H	D	W1	H1	H2	d			
A	T310-4001-H3C	120	213	150	107	199	210	M5	1.7		
	T310-4002-H3C								1.75		
	T310-4003-H3C								1.8		
	T310-4005-H3C								2.8		
	T310-4008-H3C								2.85		
B	T310-4010-H3C	215	315	212	198	284	300	M5	6.2		
	T310-4015-H3C										
	T310-4020-H3C										
C	T310-4025-H3C	256	378	234	218	360	M6	15			
	T310-4030-H3C										

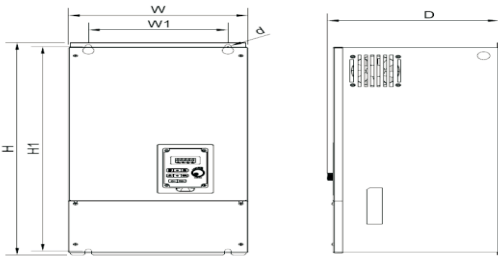

(Figure D) 380V: 40-75HP (IP20)

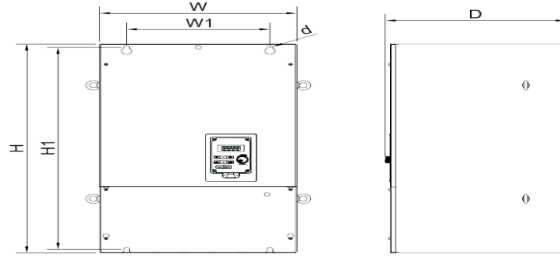

(Figure E) 380V: 100-335HP (IP00)

Figure	Inverter model	Overall dimension (mm)								Net weight (kg)	Remarks
		W	H	D	W1	H1	d				
D	T310-4040-H3C	284	535	270	220	515	M8	30			
	T310-4050-H3C										
	T310-4060-H3C										
	T310-4075-H3C										
E	T310-4100-H3C	344	600	315	250	560	M10	42			
	T310-4125-H3C										
	T310-4150-H3C										
	T310-4175-H3C										
	T310-4215-H3C										
	T310-4250-H3C										
	T310-4270-H3C										
	T310-4300-H3C										
T310-4335-H3C											
	459	790	333	320	760	M10	81				
	540	822	378	360	795	M10	110				

Product dimension

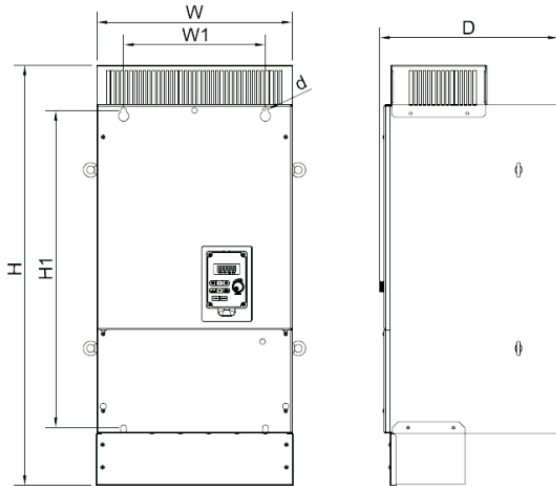

(Figure F) 380V: 375~535HP (IP20)

Figure	Inverter model	Overall dimension (mm)						Net weight (kg)	Remarks
		W	H	D	W1	H1	d		
F	T310-4375- H3C	709	896	417	530	855	M12	150	
	T310-4425- H3C								
	T310-4475- H3C	806	1015	420	530	975	M12	175	
	T310-4535- H3C								

Application

- Punching machine
- Extruder
- Air compressor
- Corrugated paper machine
- Turning machine
- Film/bottle blowing machine
- Textile machine
- Setting machine



Punching machine



Extruder

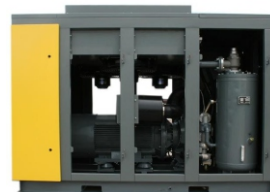

Air compressor



Corrugated paper machine

Optional accessories

Name	Model	Features	Remarks
510 series copy module	JN5-CU	Copy function: When several T310 inverters of the same model need to set the same parameters, the parameters of one inverter can be preset, and then a copy module is connected to save the set parameters. Afterwards, the copy module with saved parameters is used to copy into other machines that need to set parameters. In this way, repeated manual settings can be reduced. Simple panel function: It can be used as a panel. For specific operation, please refer to the inverter manual.	
Profibus DP communication module	JN5-CM-PDP	The JN5-CM-PDP module is developed by using the Profibus-dp fieldbus system for automated operations. This module is a gateway to combine with other basic unit operations.	38×106×59.3mm
TCP-IP communication module	JN5-CM-TCPIP	It is used to communicate with inverter/server driver and other devices that support RS485 communication protocol to realize remote control.	
DeviceNet communication module	JN5-CM-DNET	It is applied to automatic control system using DeviceNet industrial bus, and enables T310 series inverter to run on DeviceNet.	
CANopen communication module	JN5-CM-CAN	Used in the automatic control system of CANopen equipment network industrial bus, it enables T310 series inverters without CANopen function to run on CANopen network.	
RJ45 to USB communication line (1.8m)	JN5-CM-USB	It has the function of converting USB communication format into RS485 communication format to realize the communication control between inverter and PC (or other control equipment with USB interface), so that the control of inverter is more diversified.	1.8m
RJ45 to USB communication line (3m)	JN5-CM-USB-3		3m

Copy module

JN5-CU



Features

- ▲ It can copy inverter parameter settings and write them into other inverters
- ▲ It can be used separately as a remote digital operator.
- ▲ It adopts standard RJ45 network cable.

Communication module

Profibus DP, TCP-IP, DeviceNet, CANopen



Features

- ▲ It can meet the following communication protocols after the corresponding products pass through the RS485 interface of the inverter: Profibus DP, TCP-IP, DeviceNet, CANopen.

Communication Cable

RJ45 to USB communication Cable

JN5-CM-USB	1.8m
JN5-CM-USB-3	3m



Features

- ▲ It adapts to TECO's proprietary computer software cable
- ▲ It can edit the inverter parameters via computer.



TECO | Taian Technology (Wuxi) Co., Ltd.

Address: Block 65-C, National High-tech Industrial Development Zone,
Wuxi City, Jiangsu Province (No. 29, Gaolang East Road)

Telephone: 0510-85227555 Fax: 0510-85227556

Website: www.taian-technology.com

Agent / Distribution Liaison Office

VER : 1.0-2022-2